

AstroAI

Web: www.astroai.com
E-Mail: support@astroai.com

V2.1

AstroAI

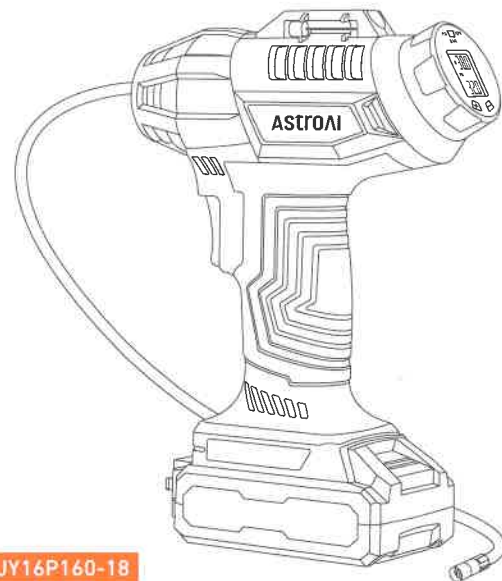

JY16P160-18

PORTABLE CAR AIR COMPRESSORS **USER MANUAL**

EN DE

ES JP

INTRODUCTION

Thank you for purchasing the AstroAI Portable Tire Inflator.

This tire inflator is compatible with the AstroAI rechargeable battery pack and standard 12 V DC power supplies. This portable tire inflator can inflate regular tires as well as other small inflatables. The rechargeable battery pack is equipped with a 5 V USB charging port, which can be used as a portable power supply to charge your electronic devices. The tire inflator will automatically shut off when it reaches the preset pressure (please ensure the set pressure is higher than the tire's current pressure). Note that the previously preset pressure value will be recalled and reapplied for the next inflation.

We hope you enjoy your new tire inflator!

Thank you again for choosing AstroAI, if you have any questions or concerns regarding your product, please contact us at support@astroai.com.

WARNING

- Please read the instructions carefully before use. Incorrect usage may damage the product.
- Please pay attention to electricity safety when using it.
- Before use, ensure the rechargeable battery pack's remaining power level is sufficient to fully inflate the desired object(s).
- Check the preset pressure value before use. The preset pressure value should match the object to be inflated.
- Please do not use this product in the rain or near any liquids.
- Keep out of reach of children, if there are children nearby ensure they are properly supervised.
- Keep the device away from fire, corrosive gases, liquids and strong magnetic fields.
- Do not aim the nozzle at people or any part of a human body.
- Contains small accessories which are a choking hazard for young children.
- Risk of electric shock, do not use this tire inflator if it is damaged or if any wires are exposed.
- Do not power this inflator with a 24 V car outlet. Only power this device with a 12 V DC, 15 A cigarette lighter outlet. Use an AC-to-DC power converter if you want to use AC power.
- Avoid extended and continuous use. The maximum time for continuous use is 20 minutes.
- After extended use, let the tire inflator rest for at least 10 minutes before using it again.

- Do not store the tire inflator in high-temperature or humid environments.
- When not in use, disconnect the tire inflator from all power sources.
- Appropriate for use with SUVs, cars, motorcycles, bicycles, decorative balloons and other inflatables. Not suitable for RVs, trucks or other large-volume objects.
- Do not overinflate tires. High-pressure air may cause injury.
- Only move the product by its handle. Do not drag the tire inflator by pulling its power cord or hose.
- During use, do not touch any part of the tire inflator other than the switch and handle. The tire inflator gets hot during use and stays hot for some time after.
- Do not use chemicals to clean the tire inflator. Only use mild soap and a cloth dipped in hot water to clean its plastic parts.
- The rechargeable battery pack should always be used in a clean, dry, well-ventilated place, please keep the tire inflator away from fire, heat and corrosive liquid.
- The rechargeable battery pack should be recharged soon after being discharged. Keeping the battery discharged for too long may reduce the battery's capacity or damage it. To maximize the battery's service life, immediately recharge it after use.
- To avoid damage, please do not charge your electronic devices while the tire inflator is pumping.

DIAGRAM

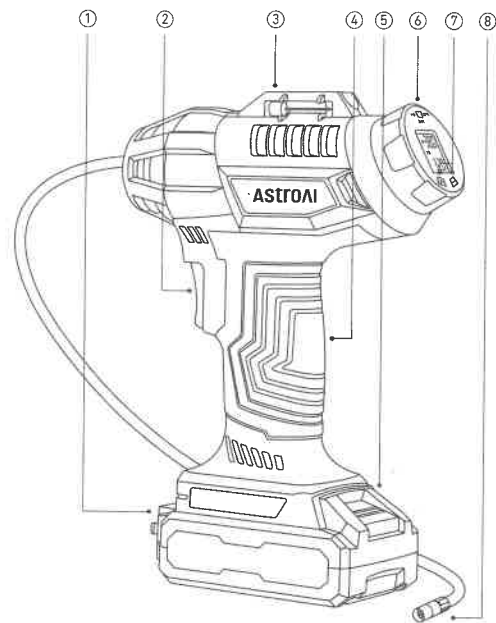

- ① 5 V USB Charge Port
- ② Trigger
- ③ Inflator Hose Storage
- ④ Handle

- ⑤ 2.0 AH Rechargeable Battery Pack
- ⑥ Unit/Power Button
- ⑦ "-" and "+" Buttons
- ⑧ Quick Connector

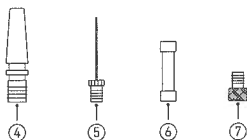
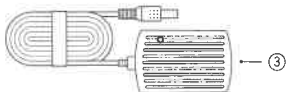
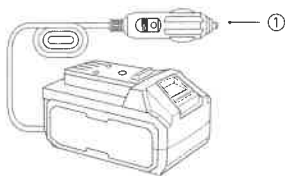

- ① 12 V Cigarette Lighter
- ② Extension Hose Coupling
- ③ 1.8 m Charger
- ④ Tapered Adapter
- ⑤ Needle Valve Adapter
- ⑥ Replacement Fuse
- ⑦ Presta to Schrader Adapter

FEATURES

- Dual power supplies, rechargeable battery pack and 12 V.
- Rapid inflation.
- Can fill a wide variety of inflatables like SUVs, cars, motorcycles, bicycles, swim rings, basketballs and more.
- The power cut memory function will automatically record and reapply the previously set pressure.
- The tire inflator automatically shuts off when the preset pressure value is reached.
- The LCD digital display provides accurate measurements. It is easy to operate, read and understand.
- Includes a 5.9 ft (1.8 m) AC cord and a 9.84 ft (3 m) DC cable.
- Easy to carry and store in a car.
- Equipped with a 5 V 2.5 A USB charge port.

PREPARATION

Charging the Rechargeable Battery Pack

1. Connect the charger to the round hole jack on the top of the rechargeable battery pack and plug in the power. Its LED light will illuminate once it has started charging.

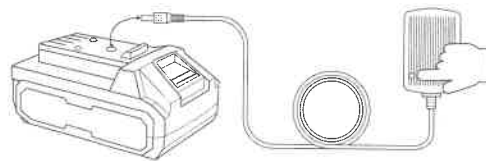

2. Press the Power Button to check the current battery level. The lights will only illuminate for a few seconds.

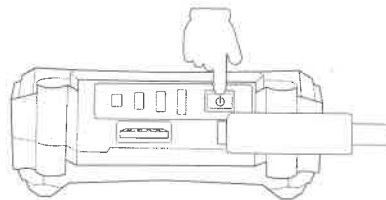

The Battery Pack's 5 V Power Supply Mode

1. The rechargeable battery pack is suitable for charging handheld electronic devices like smartphones or tablets. If the rechargeable battery pack is low on power, please recharge it as soon as possible to prolong its service life.

2. Open the silica gel charge port protector and insert the charger into the 5 V USB charge port to charge your electronic devices.

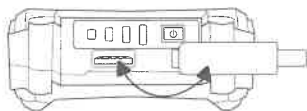

The Installment and Removal of the Rechargeable Battery Pack

1. Push the battery through the battery slot to the left until it fits, the battery is successfully installed.

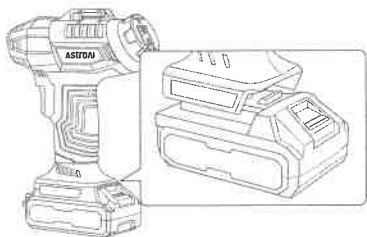

2. Hold the handle and press the button above the battery to remove the battery.

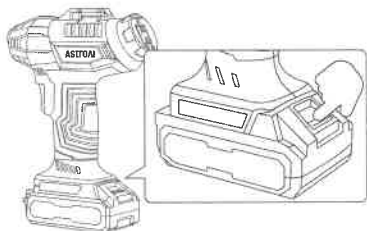

INSTRUCTIONS

Two Types of Power Supply

- Start your vehicle's engine before use and firmly plug the tire inflator into your car's 12 V outlet.
- Insert the rechargeable battery pack into the bottom of the tire inflator.

Tire Inflation

1. Insert the rechargeable battery pack into the tire inflator after it is fully charged; or plug the cigarette lighter cable into your car's 12 V outlet.
2. Press the Unit/Power Button to start the tire inflator after powering it on.
3. Press the Unit/Power Button to choose the desired unit.

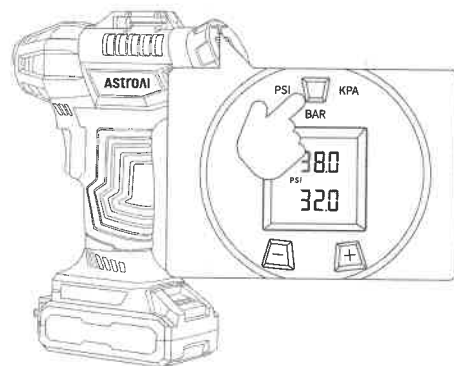

4. Use the "+" and "-" buttons to set the desired pressure. Use the tire pressure guide on the inside of the driver's door for guidance. Make sure that the preset pressure is higher than the current pressure of your tire.

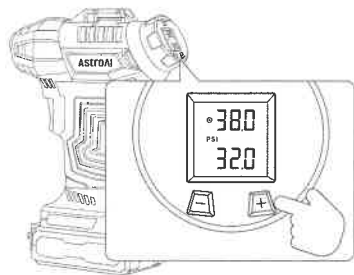

5. Remove the valve cap from the valve stem of the tire and connect the quick connector or air nozzle to the valve stem. (Note: for better sealing when using the quick connector, align the valve stem and firmly press it in. As you do this, flip the small lever.)

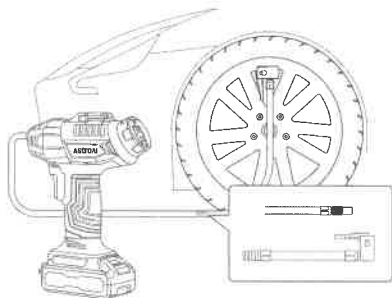

6. Press the Trigger Button to start inflating, the tire inflator automatically shuts off when the preset pressure value is reached.

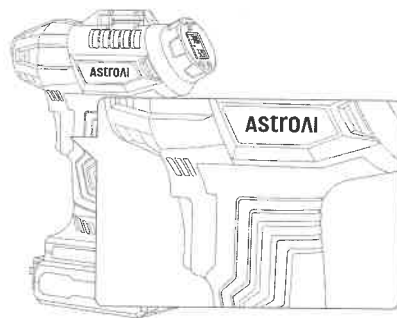

7. Press and hold the Unit Button to turn off the tire inflator after inflation. When not in use for a long time, please remove the rechargeable battery pack from the bottom.

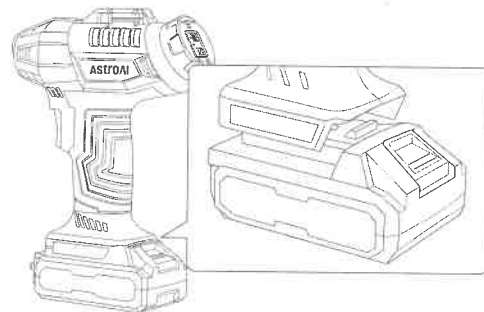

TROUBLESHOOTING

Tire Inflator Will Not Inflate

- Ensure the in-line fuse is securely and correctly inserted; replace the fuse if necessary.
- Check the vehicle's cigarette lighter fuse, it should be rated at 15 A or higher.
- Ensure there is a strong connection between the power cord and the 12 V socket.
- The preset tire is pressure lower than the current tire pressure, increase the preset tire pressure to the manufacturer-recommended level.
- Ensure the rechargeable battery pack is correctly installed in the tire inflator.
- Ensure the rechargeable battery pack is fully charged.
- Ensure the Trigger Button is pressed.

Tire Inflator Is Operating Abnormally

- The inflation nozzle is not properly connected to the tire's valve stem.
- The 12 V socket is not securely connected.
- The preset tire pressure is lower than the current tire pressure, increase the preset tire pressure to the manufacturer-recommended level.
- Insufficient battery power, the battery died during or before use. Recharge the battery and try again.

Air Leaking Through the Hose

Ensure there is a firm connection between the air nozzle and the tire valve.

Slow Inflation

- The inflation nozzle is not properly connected to the tire's valve stem.
- Excessive use will slow the inflation rate of the tire inflator. Let it cool for at least 10 minutes.

SPECIFICATIONS

Model	JY16P160-18
USB Output Voltage	5 V
Maximum Power	150 W
Inflating Speed	22 Liter/Min
Maximum Working Pressure	160 PSI
Continuous Operating Time	20 Minutes
Hose Length	19.7 in/50 cm
Extension Hose Coupling	5.1 in/13 cm
Power Cable Length	DC 9.84 ft (3 m)
Power Charger Length	AC 5.9 ft (1.8 m)
Battery Capacity	18 V 2.0 AH
Maximum Battery Voltage	20 V
Working Voltage	12 V DC/18 V Rechargeable Battery Pack
USB Output Current	Maximum 2.5 A
Dimensions	17 x 8 x 24 cm/6.7 x 3.2 x 9.5 in

PACKAGE INCLUDES

User Manual	x 1
Inflation Needle	x 1
Tapered Adapter	x 1
Presta to Schrader Adapter	x 1
Storage Bag	x 1
Extension Hose Coupling	x 1
1.8 m Power Charger	x 1
Replacement Fuse	x 1
2.0 AH Rechargeable Battery Pack	x 1
12 V Cigarette Lighter	x 1
AstroAI Portable Tire Inflator	x 1

RECYCLING

You may dispose of the product when its service life has ended, please recycle the recyclable parts according to local guidelines.

WARRANTY PERIOD

2-Year Limited Warranty from AstroAI.

Each AstroAI smart portable tire inflator will be free from defects in material and workmanship. This warranty does not cover damage from neglect, misuse, contamination, alteration, accident, or abnormal conditions of operation or handling. This warranty covers the original purchaser only and is not transferable.

AstroAI always wants to provide our customers with excellent products and customer service.

Questions or concerns? We're happy to help! Please contact us via support@astroai.com.